

YAMAHA C-50

*Natural Sound Stereo Control Amplifier
Extended Rolloff Equalizer (ERE)
New Linear Transfer Bias Circuit
Continuously Adjustable Tone Control Turnover Frequencies
MC Direct Phono Input Jacks*



OWNER'S MANUAL



Thank you for purchasing the YAMAHA C-50 stereo control amplifier.

CONTENTS	
CAUTION (PREPARED IN ACCORDANCE WITH UL STANDARD 1270)	1
CAUTION : READ THIS BEFORE OPERATING YOUR C-50	2
CONNECTION DIAGRAM	3
CONNECTIONS	4
FRONT PANEL PARTS AND FUNCTIONS	5/6/7
PERFORMANCE GRAPHS	8
SPECIFICATIONS	9
BLOCK DIAGRAM	10
TROUBLESHOOTING	11

IMPORTANT

Please record the serial number of your unit in the space below.

Model: C-50
Serial No.

The serial number is located on the rear of the cabinet.
Retain this Owner's Manual in a safe place for future reference.

WARNING

To prevent fire or shock hazard, do not expose this appliance to rain or moisture.

CAUTION (PREPARED IN ACCORDANCE WITH UL STANDARD 1270)

- 1**
Read Instructions—All the safety and operating instructions should be read before the appliance is operated.
- 2**
Retain Instructions—The safety and operating instructions should be retained for future reference.
- 3**
Heed Warnings—All warnings on the appliance and in the operating instructions should be adhered to.
- 4**
Follow instructions—All operating and other instructions should be followed.
- 5**
Water and Moisture—The appliance should not be used near water—for example, near a bathtub, washbowl, kitchen sink, laundry tub, in a wet basement, or near a swimming pool, etc.
- 6**
Carts and Stands—The appliance should be used only with a cart or stand that is recommended by the manufacturer.
- 7**
Wall or Ceiling Mounting—The appliance should be mounted to a wall or ceiling only as recommended by the manufacturer.
- 8**
Ventilation—The appliance should be situated so that its location or position does not interfere with its proper ventilation. For example, the appliance should not be situated on a bed, sofa, rug, or similar surface that may block the ventilation openings; or, placed in a built-in installation, such as a bookcase or cabinet that may impede the flow of air through the ventilation openings.
- 9**
Heat—The appliance should be situated away from heat sources such as radiators, heat registers, stoves, or other appliances (including other audio components) that produce heat.
- 10**
Power Sources—The appliance should be connected to a power supply only of the type described in the operating instructions or as marked on the appliance.
- 11**
Grounding or Polarization—Precautions should be taken so that the grounding or polarization means of the appliance is not impeded.
- 12**
Power-Cord Protection—Power-supply cords should be routed so that they are not likely to be walked on or pinched by items placed upon or against them, paying particular attention to cords at plug, convenience receptacles, and the point where they exit from the appliance.
- 13**
Cleaning—The appliance should be cleaned only as recommended by the manufacturer.
- 14**
Nonuse Periods—The power cord of the appliance should be unplugged from the outlet when left unused for a long period of time.
- 15**
Object and Liquid Entry—Care should be taken so that objects do not fall into and liquids not spilled into the inside of the appliance.
- 16**
Damage Requiring Service—The appliance should be serviced by qualified service personnel when:
 - A. The power-supply cord or the plug has been damaged; or
 - B. Objects have fallen, or liquid has been spilled into the appliance; or
 - C. The appliance has been exposed to rain; or
 - D. The appliance does not appear to operate normally or exhibits a marked change in performance; or
 - E. The appliance has been dropped, or the cabinet damaged.
- 17**
Servicing—The user should not attempt to service the appliance beyond those means described in the operating instructions. All other servicing should be referred to qualified service personnel.



**CAUTION: READ THIS BEFORE
OPERATING YOUR C-50**

1

The C-50 is a sophisticated stereo control amplifier. To ensure proper operation for the best possible sound reproduction, please read this manual carefully.

2

Choose the installation location of your C-50 carefully. Avoid placing it in direct sunlight or close to a source of heat. Also avoid locations subject to vibration and excessive dust, heat, cold or moisture. Keep away from such sources of hum as transformers or motors.

3

Do not open the cabinet as this might result in damage to the set or electrical shock. If a foreign object should get into the set, contact your dealer.

4

Do not place records or other objects on top of the amplifier so that the ventilation holes are blocked. This will cause the internal temperature to rise and may result in a failure.

5

When removing the power plug from the wall outlet, always pull directly on the plug; never yank the cord.

6

Do not use force when using the switches and knobs.

7

When moving the unit be sure to first pull out the power plug and remove cords connecting to other equipment.

8

Always set the volume control to "∞" while lowering the tonearm to play a record, then turn the volume up after the stylus is seated in the record groove.

9

Do not attempt to clean the C-50 with chemical solvents as this might damage the finish. Use a clean, dry cloth.

10

Be sure to read the "troubleshooting" section for advice on common operating errors before concluding that your C-50 is faulty.

11

Keep this manual in a safe place for future reference.

12

Do not connect audio equipment to the AC outlets on the rear panel if that equipment requires more power than the outlets are rated to provide.

C-50

CONNECTION DIAGRAM

Be sure to connect the left (L) and right (R) channels consistently from component to component.

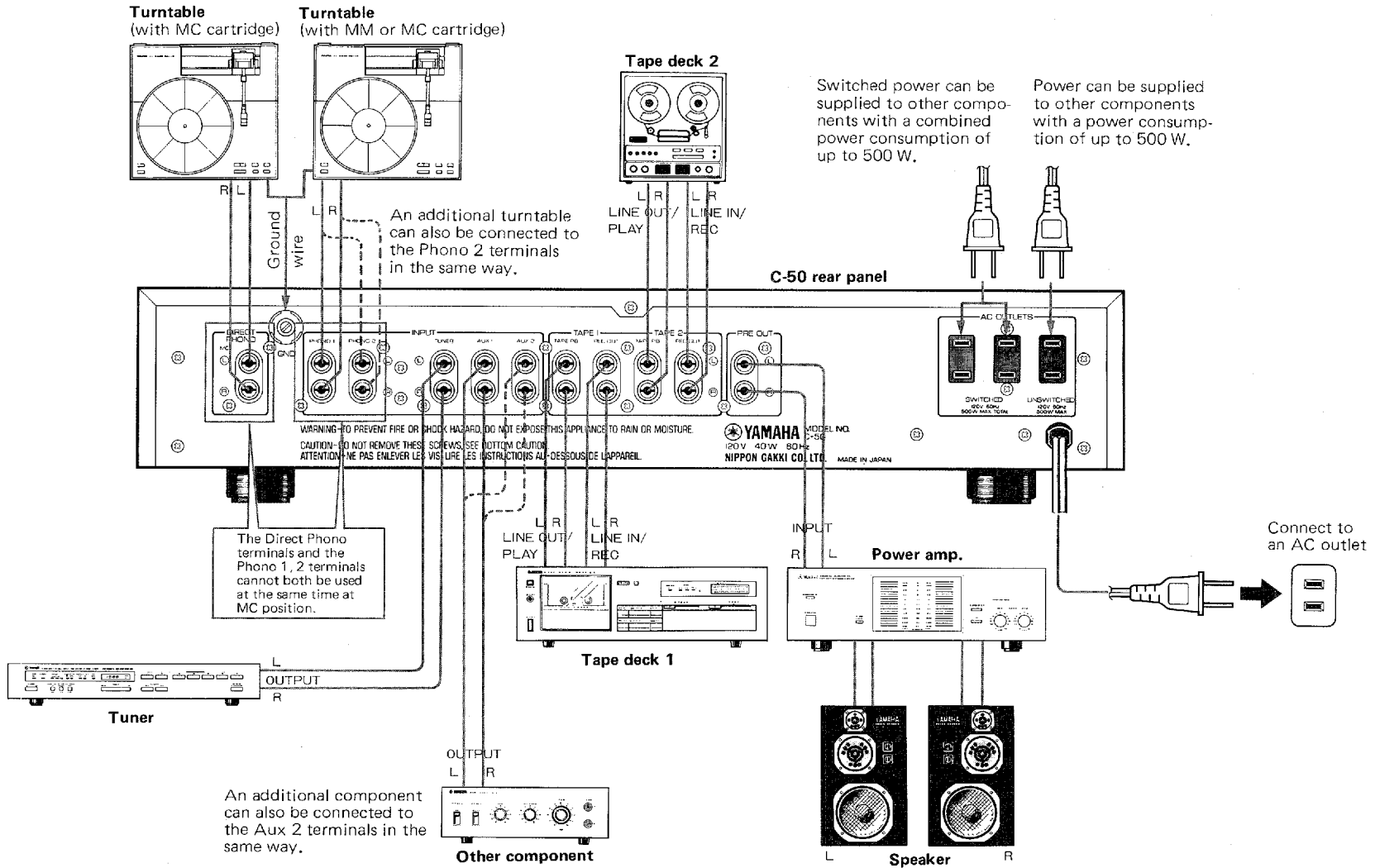

CONNECTIONS

■ CONNECTING A TURNTABLE

The C-50 has Direct Phono MC input terminals that ensure the shortest possible signal path with the minimum number of switch contacts from an MC cartridge to the amplifier circuitry. When using a single turntable that is equipped with an MC cartridge it is recommended that these direct terminals be used. In all other cases be sure to use the Phono 1 and/or Phono 2 terminals (MC or MM OK). Plug each turntable's output cords into the appropriate PHONO jacks firmly, making sure that the left and right channels are not reversed. Connect the turntable's ground wire to the C-50 Gnd terminal. Normally, connecting the ground wire produces minimum hum, but in some cases better results are obtained with the ground wire disconnected. When the Phono 1 and Phono 2 terminals are being used, the front panel Phono 1, 2 pushbutton is used to select between them. However, when the Direct MC terminals are used, this pushbutton has no effect. In either case the Phono rotary switch should be set to match the cartridge type and impedance.

* When you use the Direct Phono terminals, do not use the Phono 1, 2 terminals at MC position.

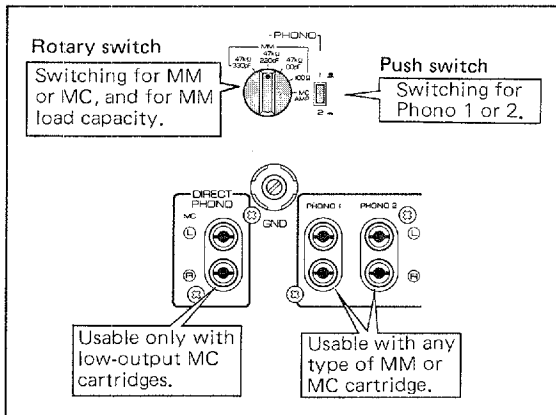

■ CONNECTING A TUNER

Connect cords from the tuner's output jacks to the Tuner jacks of the amplifier.

■ CONNECTING A TAPE DECK

Two tape decks can be connected to this amplifier as it has two sets of jacks (Tape 1 and Tape 2). Connect the Tape PB jacks to the tape deck's Line Out jacks, and the Rec Out jacks to the tape deck's Line In jacks.

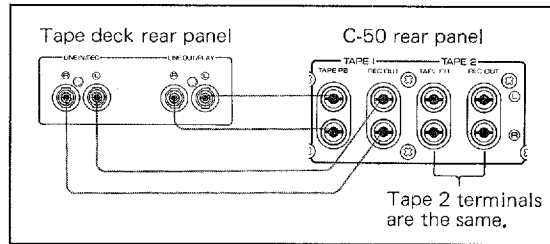

■ AUX TERMINALS

These terminals are useful for connecting a third tape deck (playback only), a second tuner, or other sources. Notice that a turntable cannot be connected to the Aux terminals because no RIAA equalization is provided.

■ CONNECTING THE POWER AMP

Connect cords from the Pre Out jacks of the C-50 to the input jacks of your power amplifier. Be sure that the connections are firm and that the left and right channels are not reversed.

■ AC OUTLETS

For your convenience, the C-50 provides 3 AC Outlets (2 switched and 1 unswitched) on the rear panel. Be sure not to connect appliances totalling more than 500 watts to the 2 switched outlets or more than 500 watts to the unswitched outlet.

C-50

FRONT PANEL PARTS AND FUNCTIONS

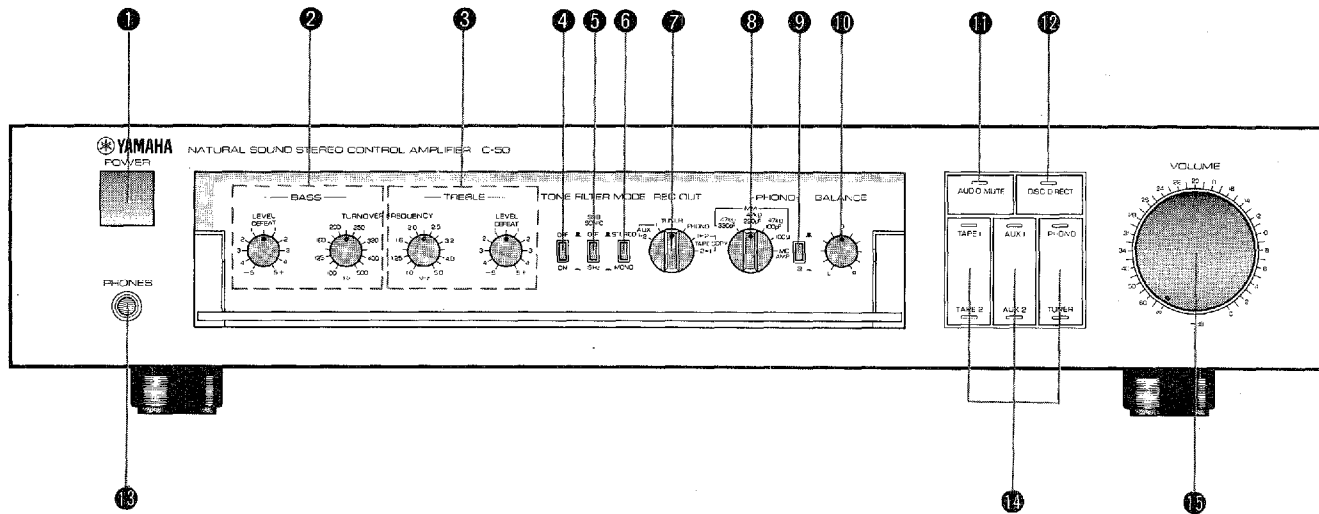

1 POWER SWITCH

This is a "push-on, push-off" type power switch. The Volume control should be turned all the way down before turning on power.

■ TONE CONTROLS

The C-50's Tone Controls offer extensive frequency response control. They can be used to correct for the acoustics of your room, for the placement of your speakers, or to adjust the sound to your personal preference. A Bass control and a Treble control are provided, each with its own adjustable Turnover Frequency and Level. A center Defeat position is provided.

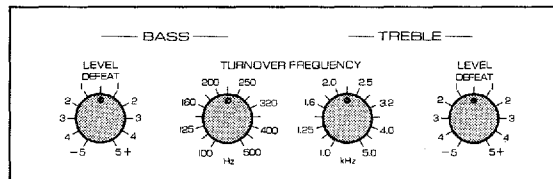

2 BASS CONTROL

The Turnover Frequency of the Bass control can be varied from 100 to 500 Hz. Rotating the level control to the left decreases the bass frequencies while rotating it to the right increases them. The center Defeat position produces flat response.

3 TREBLE CONTROL

The Turnover Frequency of the Treble control can be varied from 1.0 to 5.0 kHz. Rotating the level control to the left decrease the treble frequencies while rotating it to the right increases them. The center Defeat position produces flat response.

4 TONE SWITCH

Turn the switch on to activate the tone controls and allow full sound tailoring capabilities. Turn the switch off to disable the tone controls for completely flat response.

5 SUBSONIC FILTER

This switch lets you cut out ultra-low-frequency signals without affecting the quality of audible sounds. Caused by turntable rumble or warped records, etc. these subsonic interference signals can sap vital power from the amplifier or even harm speakers not attenuated.

6 MODE SWITCH

Allows switching between stereo or mono operation. Normally the switch should be set for stereo.

7 REC OUT SELECTOR

Used for recording, this switch sends the signal from the selected source to the Rec Out jacks (regardless of the state of the input selector switches). Press the input selector switch of the same source if you want to monitor the source as you record, or of any other source to listen to that source while recording. If your tape deck has three-head monitoring capability, you can monitor the signal just recorded on the tape by pressing the corresponding tape input selector switch.

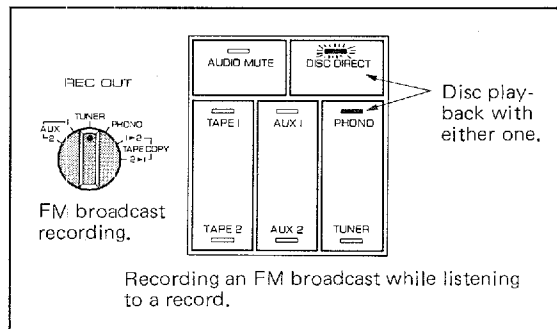

Independent Recording and Listening Examples

Rec Out selector	Input selector	Action
Tuner	Phono	Listening to a record with the speakers while recording an AM or FM broadcast.
Tuner	Tuner	Listen to an FM or AM broadcast with the speakers while recording it.
Phono	Phono	Listen to a record with the speakers while recording it.
Phono	Tuner	Listen to an FM or AM broadcast with the speakers while recording a record.

Tape Dubbing

Dubbing from the deck connected to the rear panel Tape 1 connectors to the deck connected to the Tape 2 connectors.

1. Set the Rec Out selector to the Tape Copy 1 ► 2 position.

2. Set deck 1 to Play and deck 2 to Record.

To dub from deck 2 to deck 1, set the Rec Out selector to the Tape Copy 2 ► 1 position, set deck 2 to Play and 1 to Record.

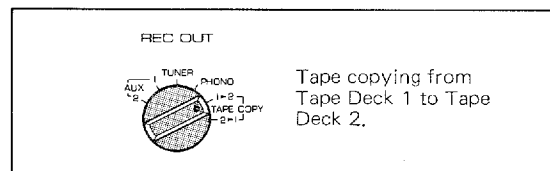

8 PHONO TYPE/IMPEDANCE SELECTOR

Selects either MC or MM cartridge type. In addition, for MM cartridges the switch selects cartridge load impedance. Refer to the instructions for your MM cartridge to determine the proper load impedance.

9 PHONO 1, 2 SWITCH

In the case where the Direct Phono MC input jacks are being used, this switch has no effect. When the Phono 1 and Phono 2 jacks are being used, this switch selects turntable 1 or turntable 2.

10 BALANCE CONTROL

Turning the balance control to the right reduces the left channel volume, while turning it to the left reduces the right channel volume. This allows you to compensate for imbalance caused by asymmetry in left and right speaker locations, furniture arrangement, or in the source program. An easy way to adjust the balance control is to set the Mode switch to Mono, adjust the Balance slider for equal volumes from the left and right speakers, and press the Mode switch again to restore stereo operation.

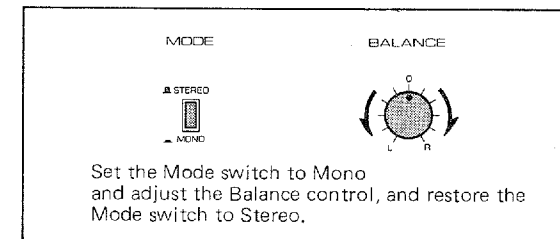

C-50

11 AUDIO MUTE SWITCH

Pressing this switch lowers the volume 20 dB, a convenient way to lower the volume temporarily without disturbing the volume control position. Press the switch again to restore normal volume.

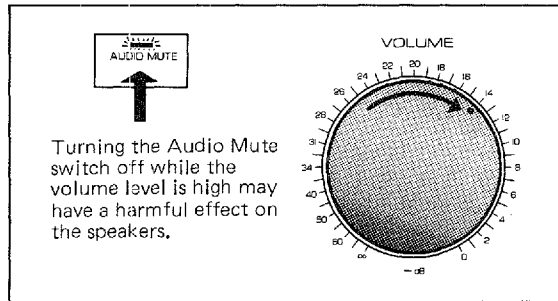

12 DISC DIRECT SWITCH

Pressing this switch lights the indicator and sets the amplifier up for disc-only operation. The following functions are completely bypassed, greatly shortening the signal path:

- Tone Controls
- Tone Switch
- Mode Switch
- Input Selector Switch

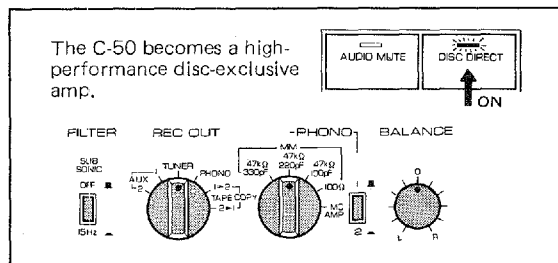

Optimizing the amplifier for disc play in this way allows flatter frequency response and more accurate music reproduction. The switch is also useful for turning all the above-listed functions with one touch, making it easy to determine their effect on the sound.

When the Disc Direct switch is on, the indicators on the Input Selector switches will be dimmed.

13 AUDIO MUTE/DISC DIRECT MEMORY

The C-50 remembers the states of the Audio Mute and Disc Direct switches even when power is turned off, making it unnecessary to reset them when the unit is turned on.

15 PHONES JACK

One headphone jack is provided. Plugging in the headphones mutes the audio output to the power amp for private listening.

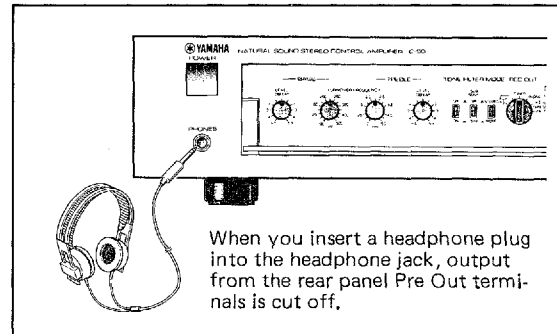

14 INPUT SELECTOR SWITCHES

These select the program source to be listened to. Note that the Disc Direct switch overrides the input selector switches.

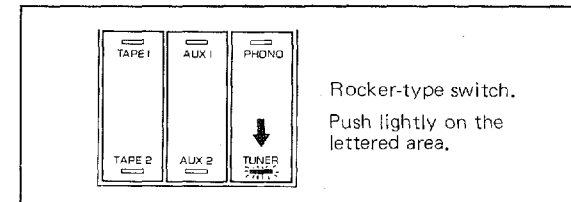

16 VOLUME CONTROL

Used to adjust overall sound volume. Calibrated in decibels.

PERFORMANCE GRAPHS

■ Tone Control Characteristics

● BASS Control

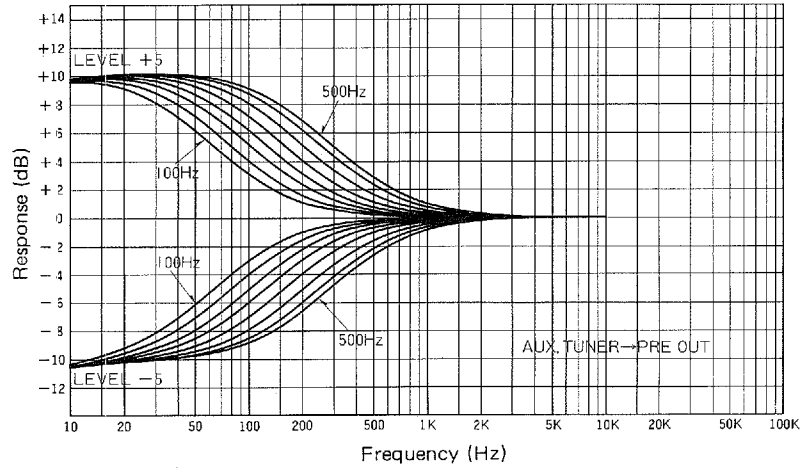

● TREBLE Control

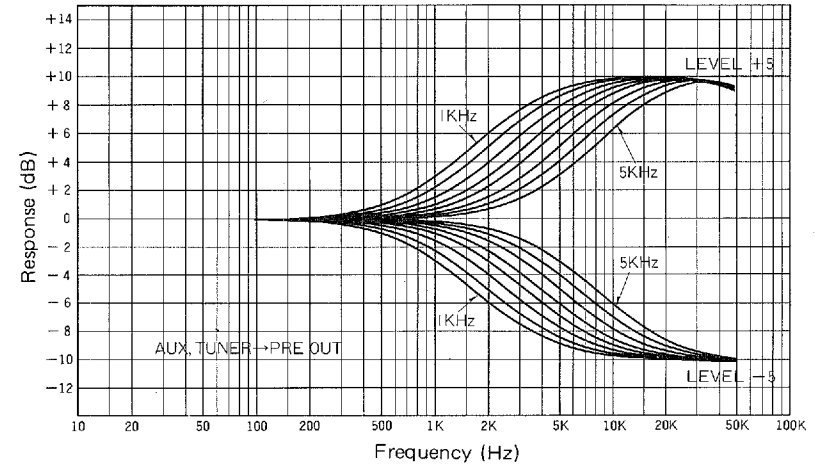

■ Phono Harmonic Distortion / Input Level

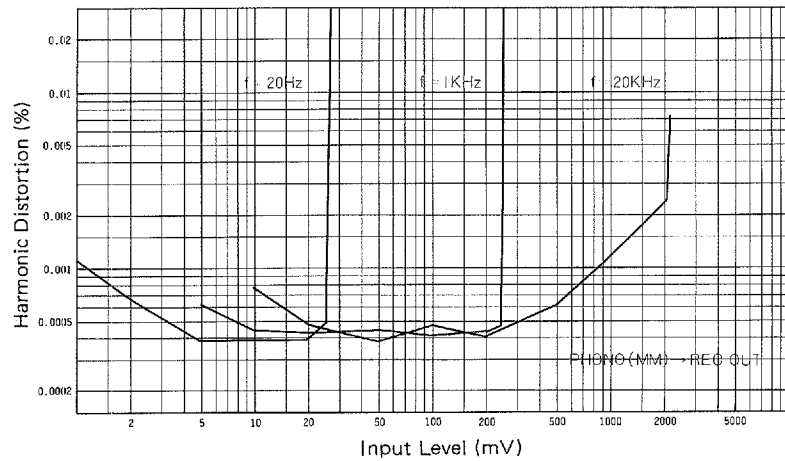

■ RIAA Equalization Characteristics

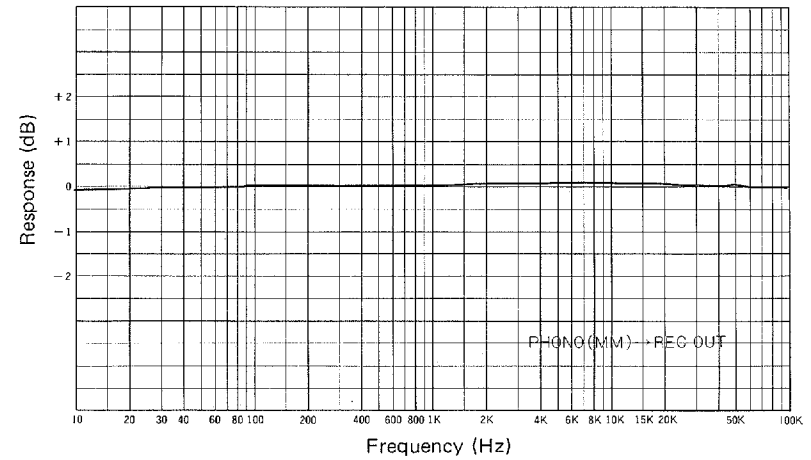

C-50

SPECIFICATIONS

Input Sensitivity/Impedance

Phono MC	100 μ V/100 ohms
MM	2.5mV/100 ohms
	2.5mV/47 kohms 100pF
	2.5mV/47 kohms 220pF
	2.5mV/47 kohms 330pF
Aux, Tape, Tuner	150mV/47 kohms

Input Sensitivity (New IHF)

Phono MC	33 μ V
MM	0.83mV
Aux, Tape, Tuner	50mV

Maximum Input Level (1 kHz, 0.01% THD/New IHF)

Phono MC	8.5mV/8mV
MM	220mV/220mV

Output Level/Impedance

Rec Out	150mV/470 ohms
Pre Out	1.5V/47 ohms

Maximum Output Level (20 Hz ~ 20 kHz, 0.1% THD)

Pre Out	10V
---------	-----

Headphone Maximum Output Level/Impedance

(1 kHz, 0.01% THD, Output impedance 68 ohms)	0.45V/8 ohms
	4.0V/100 ohms

Frequency Response

Aux, Tape, Tuner to Pre Out	+0, -0.5dB (DC ~ 100 kHz)
--------------------------------	------------------------------

RIAA Deviation

Phono MC, MM	\pm 0.2dB (20 Hz ~ 20 kHz) \pm 0.5dB (10 Hz ~ 100 kHz)
--------------	---

Total Harmonic Distortion (20 Hz ~ 20 kHz)

Phono MC to Rec Out	0.002% (3V output)
MM to Rec Out	0.001% (3V output)
Aux, Tape, Tuner to Pre Out	0.001% (5V output, Tone switch OFF)

Intermodulation Distortion (Tone switch OFF)

Aux, Tape, Tuner	0.002% (5V output)
------------------	--------------------

Signal to Noise Ratio (IHF-A-Network)

Phono MC	90dB (500 μ V, Input shorted)
MM	93dB (5mV, Input shorted)
Aux, Tape, Tuner	105dB (Tone switch OFF)

Signal to Noise Ratio (New IHF)

Phono MC	80dB
MM	81dB
Aux, Tape, Tuner	96dB

Residual Noise

(IHF-A-Network)	2.5 μ V
-----------------	-------------

Channel Separation

Phono MM	40 Hz	85dB (Input shorted)
	1 kHz	80dB (Input shorted)
	10 kHz	68dB (Input shorted)
Aux, Tape	40 Hz	85dB (5.1 kohms)
	1 kHz	70dB (5.1 kohms)
	10 kHz	53dB (5.1 kohms)

Tone Control Characteristics

Bass (boost/cut)	\pm 10dB
Bass Turnover Frequency	100 ~ 500Hz
Treble (boost/cut)	\pm 10dB
Treble Turnover Frequency	1 ~ 5 kHz

Subsonic Filter Characteristics

.15Hz, -12dB/oct

Audio Muting

-20dB

General

Power Supply	AC 120V, 60 Hz
Power Consumption	40W
AC Outlets	500W max total (Switched x2) 500W max (Unswitched x2)
Dimensions (W x H x D)	435 x 96.5 x 369 mm (17-1/8 x 3-3/4 x 14-1/2")
Weight	6.8 kg (15.0 lbs)

Specifications subject to change without notice.

BLOCK DIAGRAM

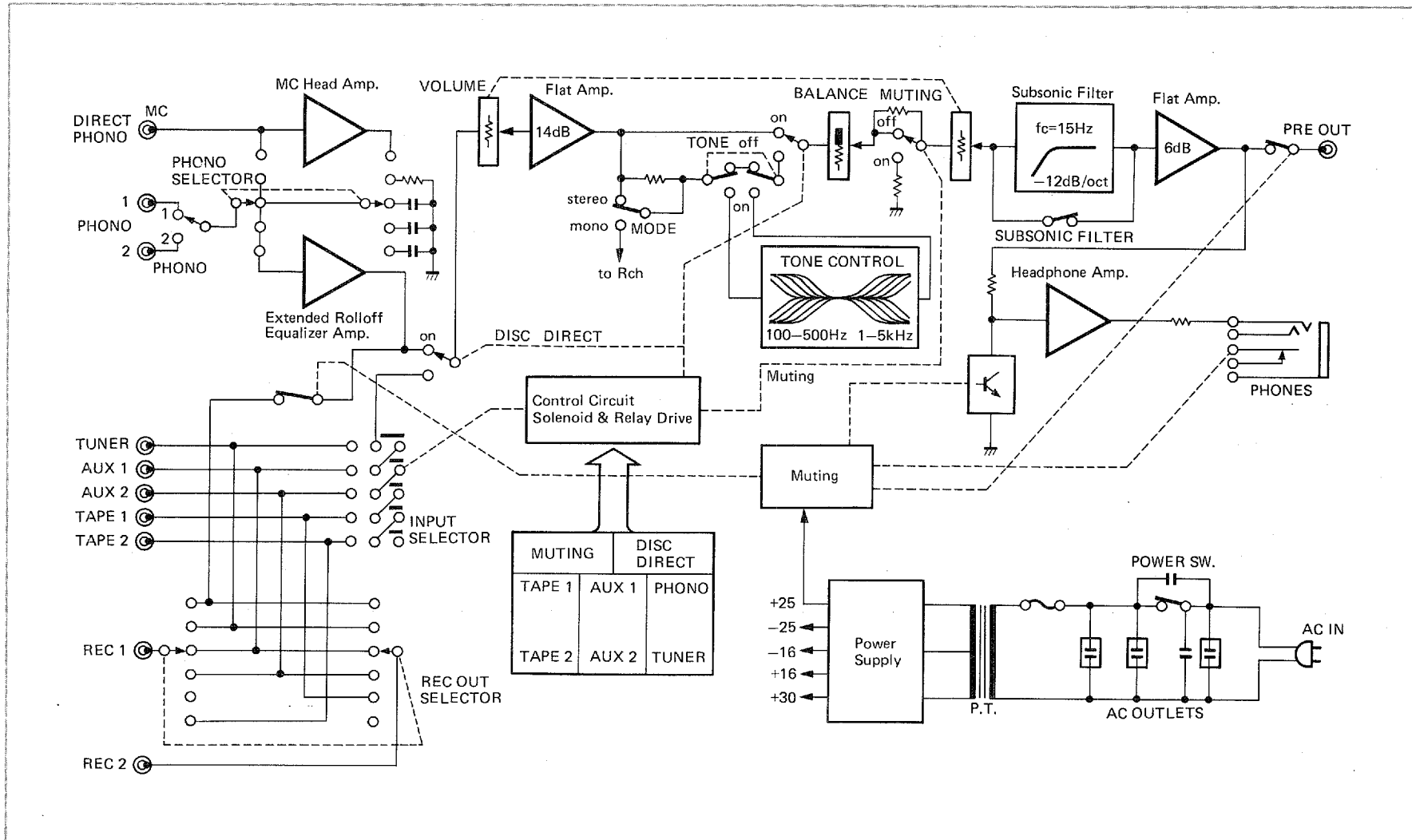

C-50

TROUBLESHOOTING

Before assuming that your amplifier is faulty, check the following troubleshooting list which details the corrective action you can take yourself without having to call a service engineer. If you have any doubts or questions, get in touch with your nearest Yamaha dealer.

Fault	Cause	Cure
Power is not supplied even the Power switch is turned on.	The power plug is not securely plugged in.	Plug it in securely.
No sound is heard.	Input switches set incorrectly.	Set input switches to source you want to hear.
	The Disc Direct switch is on.	Set the Disc Direct switch to off except when playing a disc.
	The power amp is not connected correctly.	Check and secure connections.
	The input terminals are not connected securely.	Connect them securely.
Sound from MC cartridge is low.	The Phono rotary switch is set to an MM position.	Set the switch to MC Amp.
Turning the tone controls does not affect the tone.	The Tone switch is off.	The Tone switch must be turned on to use the tone controls.
A loud humming sound is heard during record play.	Turntable's ground wire is not connected to amplifier's ground terminal.	Connect the wire. (Sometimes better results can be obtained without the wire.)
Unable to record.	Rec Out selector set improperly.	Set Rec Out to source you are recording.
Volume is too low even when the Volume control is turned up.	The Audio Mute switch is on.	Turn the Audio Mute switch off.